

# Push Switch 2.5mm-travel Horizontal Type

SPPJ2 Series

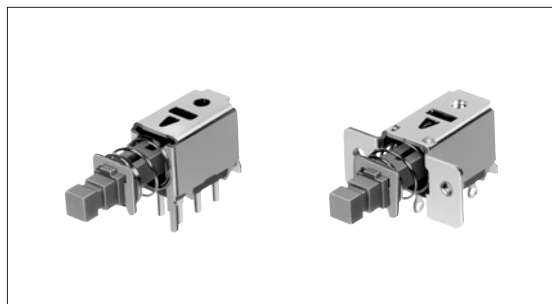

Switches with a lever height of 5.5 mm, directly mountable onto sets.



## Features

- 5.5mm in lever height from the mounting surface of a PC board.
- Both printed wiring and lead wiring available.
- Available in various types of standard knobs.

## Applications

- For PC peripherals, in-car components, electronic music instruments, visual devices and various electronic devices
- For volume controlling, mode changing and cursor control in car AV equipment, car navigation systems

## Typical Specifications

Items		Specifications
Rating (max.)/(min.) (Resistive load)		0.2A 30V DC/50 $\mu$ A 3V DC
Contact resistance (Initial /After operating life)		20m $\Omega$ max./40m $\Omega$ max.
Operating force		3 $\pm$ 1.5N
Operating life	Without load	10,000cycles
	With load	10,000cycles (0.2A 30V DC)

## Product Line

Changeover timing	Travel (mm)	Total travel (mm)	Rating	Mounting method	Poles	Operation	Terminal style	Minimum packing unit (pcs.)	Product No.	Drawing No.
Non shorting	2.5	3.5	—	PC board	2	Latching	For PC board	100	SPPJ222200	1
						Momentary			SPPJ223200	
				M2-screw		Latching	Lead		SPPJ225800	2
						Momentary			SPPJ226400	

## Note

Products other than those listed in the above chart are also available. Please contact us for details.

Refer to **P.105** for product specifications.  
Refer to **P.106** for knobs.

Detector

Push

Slide

Rotary

Encoders

Power

Dual-in-line  
Package Type

Multi Control  
Devices

TACT Switch™

Custom-  
Products

Horizontal  
Type

Vertical  
Type

Dimensions

Unit:mm

No.	Style	PC board mounting hole dimensions (Viewed from the direction A)
1	For PC board	
2	Lead	

Actuator configuration at front edge Unit:mm

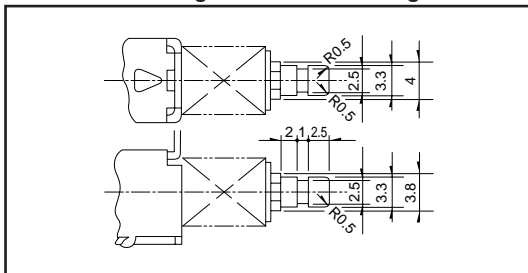

Terminal Configuration Unit:mm

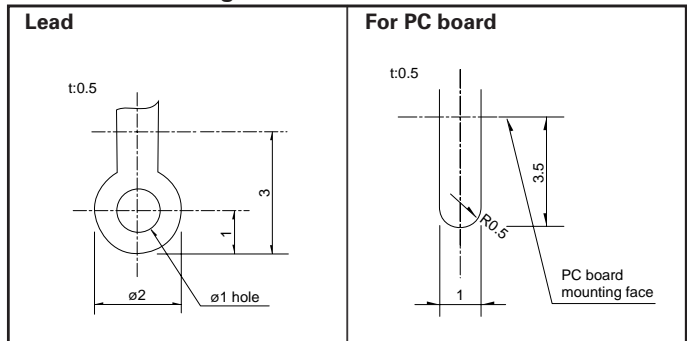

Circuit Diagram (Viewed from the Direction A)

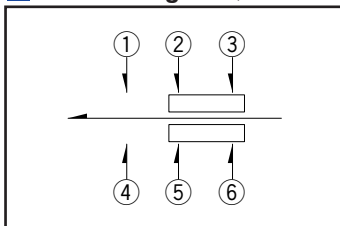

- Detector
- Push**
- Slide
- Rotary
- Encoders
- Power
- Dual-in-line Package Type
- Multi Control Devices
- TACT Switch™
- Custom-Products
- Horizontal Type
- Vertical Type



## Attached Parts

Please specify required knob.

Unit:mm

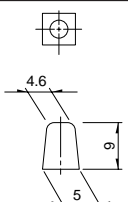
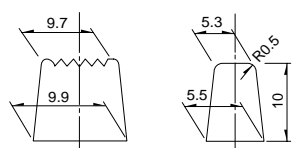
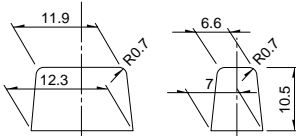
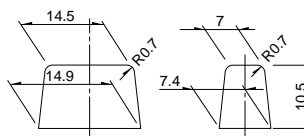
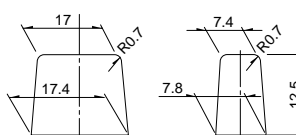
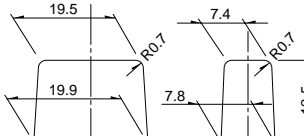
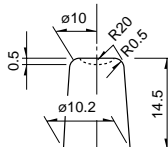
Knob outline drawing	Variety		Series
	Color	Model	
	Black Red White	UJ206022 UJ206020 UJ206026	SPPJ3 SPUJ
<b>Key pitch 10mm</b>  <b>Square knob</b> 		4093-1 4093-2 4093-3	
<b>Key pitch 12.5mm</b>  <b>Square knob</b> 		UE201011 UE201012 UE201013	
<b>Key pitch 15mm</b>  <b>Square knob</b> 		UE202011 UE202012 UE202013	SPPJ2 SPUP SPUN SPEC
<b>Key pitch 17.5mm</b>  <b>Square knob</b> 		UE203011 UE203012 UE203013	
<b>Key pitch 20mm</b>  <b>Square knob</b> 		UE204011 UE204012 UE204013	
<b>Round knob</b> 		UE200011 UE200012 UE200013	

### Note

We recommend the use of adhesive to secure the knob when mounting onto switches.

